



Dual Alarm Clock

with UVC Sanitizer

Let's Get Started!



1 Plug in



Plug the included power cable into the **DC 5V** jack on the back of the clock/sanitizer.

Plug the other end into a power outlet or surge protector.

BATTERY BACKUP

Your clock has a pre-installed battery backup that will keep the time in case power is interrupted (like by a power outage, for example). If you notice that battery backup is no longer working, simply replace the CR2032 coin-cell battery behind the circular battery door in the sanitizing compartment. Use a coin to open the battery door and access the CR2032 battery.

2 Set the time

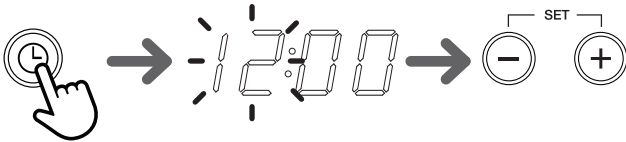

Press and hold the button on the top of the clock/sanitizer until the hours digits flash.

Use the **+** and **-** buttons on the top of the clock/sanitizer to adjust the hour. Press to set.

Use the **+** and **-** buttons to adjust the minutes. Press to set.

Use the **+** and **-** buttons to choose 12- (AM/PM) or 24-hour time. (12-hour time is the default.) Press to finish setting the time.

3 Load up the sanitizer

Open the cover of the clock/sanitizer. Then place the item you want to sanitize inside.

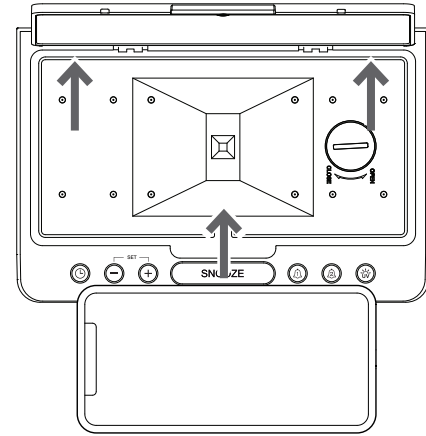

Charge up, too!

The clock/sanitizer can charge your mobile device too! Just plug your charging cable (not included) into the charging port inside the clock/sanitizer.

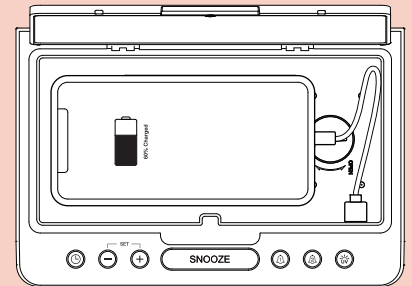

4 Sanitize!

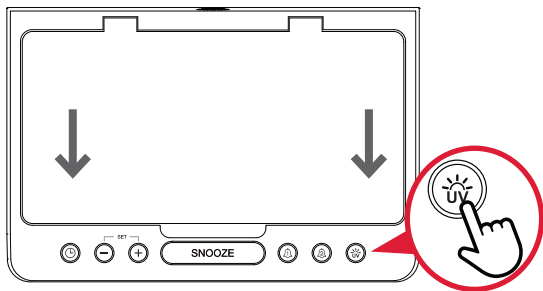

Close the cover and choose the sanitization cycle you want to use.

For these items	Use this cycle	To start:
Hard, non-porous (like phones, tablets, watches and remote controls)	Standard cycle (around 10 minutes)	Press the button.
Fabric and soft porous (like facemasks, toothbrushes, and makeup brushes)	Deep clean cycle (around 20 minutes)	Press and hold the button until the indicator on the clock display flashes twice.

The indicator on the clock display turns on during sanitization. It turns off when the sanitization cycle is complete.

To stop sanitization before the cycle is complete: Press the button. The indicator on the clock display flashes three times to indicate the cycle has stopped and it's safe to open the cover.

Notes:

- The indicator flashes if the cover is open when you try to start sanitization. For your safety, the sanitizer cannot proceed with sanitization if the cover is open. Make sure the cover is completely closed, then press the button again.
- You can use the deep clean cycle even for items that don't need it. There's no harm done to the item—it just takes longer to finish the cycle.

5 Get your clean stuff

Open the cover of the clock/sanitizer. Remove the item you placed inside — it's safe to use now!

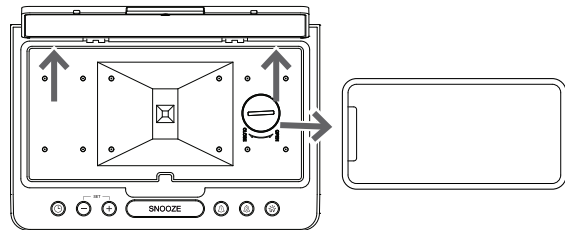

6 Set the alarms (optional)

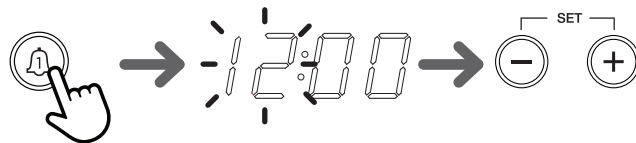

To set the time for alarm 1 (🔔):

Press and hold the 🔔 button on the top of the clock/sanitizer until the hours digits flash on the display.

Use the + and — buttons on the top of the clock/sanitizer to adjust the hour. Press 🔔 to set.

Use the + and — buttons to adjust the minutes. Press 🔔 to set.

To set the time for alarm 2 (🔔): Follow the steps above, using the 🔔 button instead of 🔔.

To turn an alarm on/off: Press the button for the alarm you want to turn on or off (🔔 or 🔔). The alarm time appears on the display and the indicator on the display shows that you've turned that alarm on or off. Press the ⌚ button to display the current time.

Tour of the Dual Alarm Clock with UVC Sanitizer

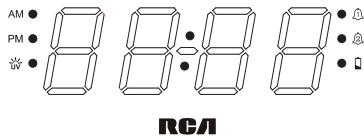

RCA

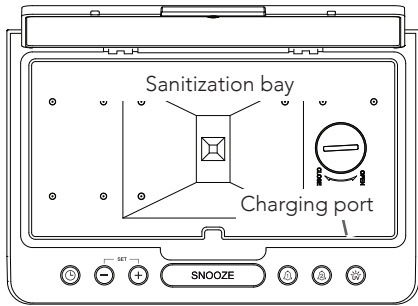

DISPLAY

AM and PM indicators show if the time displayed is AM or PM in 12-hour time format.

UV indicator turns on when the sanitizer is in use. When it turns off, open the top and remove your items.

and indicators show if alarm 1 and/or alarm 2 are active.

indicator turns on when the backup battery needs to be replaced. See step 1 for details.

TOP AND SANITIZATION BAY

button lets you set the time (press and hold) or display the current time (press).

+ and – buttons adjust the flashing digits when setting the time or alarm.

SNOOZE button temporarily delays the alarm another 9 minutes until you turn it off. The alarm times out after 1 hour if no buttons are pressed. To stop an active alarm, press any button except snooze. **Note:** you cannot sanitize during an active alarm—if you press the **UV** button it stops the alarm. This button also adjusts the display brightness.

UV button starts the sanitization process once the top is closed. You can choose the standard cycle (press) or deep clean cycle (press and hold). Press this button during a sanitization cycle to stop the cycle before it's complete. The **UV** indicator flashes three times to indicate the cycle has stopped and it's safe to open the cover.

and buttons let you set the alarm times (press and hold) or turn each alarm on/off (press).

The **sanitization bay** is where you put the item you want to sanitize. Once you've closed the top and pressed the **UV** button, the item in the bay receives a bath of UVC rays that kill bacteria and viruses.

IMPORTANT: The UVC lights automatically turn off when the top of the bay is opened.

The **charging port** charges your mobile device when the clock/sanitizer is plugged in. Just plug your charging cable into the port—your device charges both when the clock/sanitizer is sanitizing and when it's not.

About UV sanitizing

Ultraviolet (UV) light is invisible to the human eye. The UVC part of the UV spectrum is proven to have germicidal benefits, killing bacteria and deactivating viruses. It is important to use the product with appropriate safeguards and follow safety precautions.

UV light is most effective on hard, non-porous surfaces such as phones, most phone cases, keys, credit cards, etc. UV light is less effective against fabrics and other porous materials because of the many shadows they create that may block the UV light from hitting the surface. The UV light can only kill germs on surfaces with which it comes in contact.